

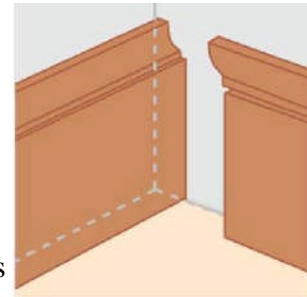

How to Cope Mouldings

About Coped Joints

Coping is a wood joinery technique that ensures professional looking results. This is especially true with moulding patterns that are larger and more ornate, and rooms where the corners are not square. In a coped joint, one side is square cut and rests in the corner, while the other piece is shaped to fit as shown at right.



Why make coped joint.

Even if you measure accurately and cut carefully, there are several disadvantages to simple mitre cuts. Corners of a room are rarely square. Mouldings can expand or contract in different seasons, or as the house ages. As you nail your mouldings to the wall during installation, they tend to separate at the corners. The overlapping surfaces of a coped joint solves many of these problems.

Coped joints procedures are also discussed in other documents in this series that discuss door and window moulding installations, crown and ceiling mouldings, etc.

Tools for Coped Joints

A good coping saw with a sharp blade, and a tightly adjusted frame is very helpful in creating good coped joints. A good manual or powered mitre saw is also helpful for making the preliminary cuts prior to coping.

If you have a large moulding installation project, a powered mitre saw or chop saw fitted with a crosscut blade is highly recommended. A powered miter saw will provide far better results than a miter box and saw. A powered saw allows you to make fine adjustment and tapered cuts that are often necessary for perfect miter joints. It is also possible rent power miter saws by the day.

If you are not experienced using a particular power tool, obtain and read the tool's operator manual (often available from the manufacturers website) or consult a book on using such tools. If renting a tool, ask the dealer to explain safe operating procedures.

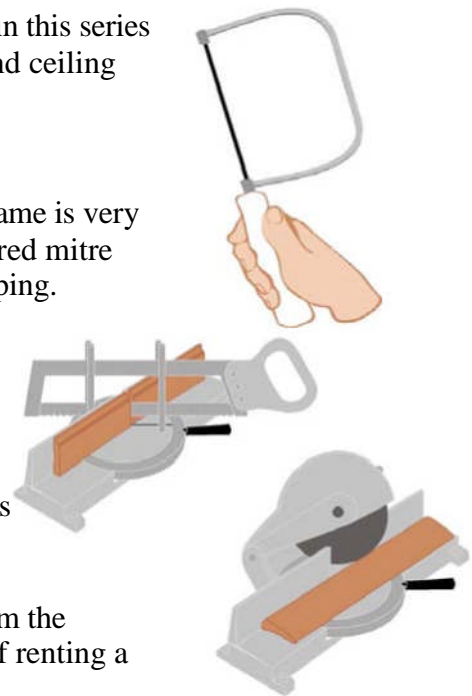

Safety: Always wear eye protection when using hand or power tools, especially while cutting, nailing, chiseling or demolition. Keep your work area safe at all times. To prevent injury, bend over or pull nails from any moulding that has been removed.

Preparing to Install Mouldings

The tools you need to install mouldings vary depending on the type of installation and finish wood treatment.

Tools & Equipment Required:

- **Finish hammer**
- **Hand plane:** for trimming jamb extensions
- **Measuring tape**
- **Carpenter's glue**
- **Sanding Block and 120-grit sandpaper**
- **Jigsaw:** for notching stool and profiling apron.
- **Combination Square:** for marking casing, stool, and apron
- **Pencil**
- **Utility knife, and Chisel:** for trimming drywall, adjusting fit of trim
- **Putty Knife**
- **Nail set:** to recess heads of hand-driven nails
- **Miter saw equipped with Cross-cut or combination blade:** for cutting trim pieces to length
- **Drill with 1/16-inch-diameter bit:** for making pilot holes

Optional:

- **Pneumatic nailer:** for attaching casing
- **Random-orbit sander**
- **Router :** for making stool profile (if making your own)
- **Table saw** for cutting rabbet in bottom of stool (if making your own)

Removing Existing Moulding

Existing casings will often have built-up paint or caulking where the casing meets the wall surface, and where the casing meets the door jamb or other trim pieces. If so, use a utility knife to score these seems.

Use a pry bar or sturdy putty knife to separate the casing from the wall material. Then use a pry bar and a hammer to carefully separate the casing from the wall surface (place a piece of scrap wood or similar material on the wall material to avoid damage from your tools).

On doors and windows with stools, aprons, blocks or other trim, remove casings first, then aprons, then stools or other trim pieces.

Basic Coping Cuts - Base Corners

The Tracing method

One method of preparing a coping joint is to trace the pattern of the moulding on the back of another as a cutting guide. Getting the exact orientation of the pieces is crucial to an accurate coping joint.

1) Cut the first piece of the moulding so it fits flush against the wall (in this example, the Left side)

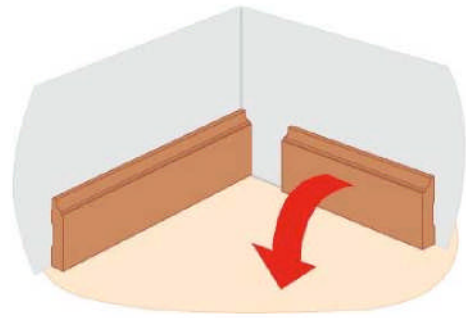

2) Position the other piece of moulding in the orientation it will be installed, and flip it down as shown in the drawing.

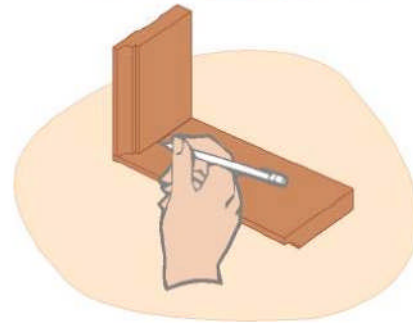

3) Take a scrap piece of moulding and place it as shown. Trace the pattern on the back of the moulding to create a cutting line.

4) Using the coping saw, cut along the cutting line, angling the coping saw slightly so more material is taken from the back side of the moulding.

5) Test fit the moulding pieces. You might need to cut away additional material from the coped piece of moulding, but do not cut past the cutting line.

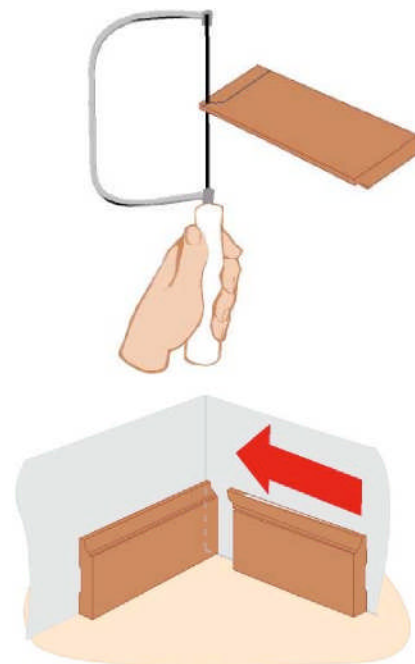

The Mitre Cut method

Another method of preparing a coping joint is to mitre cut the coped piece of moulding with a simple 45 degree mitre cut. The cut edge resulting from this mitre cut acts as the cutting line for the coping saw.

To prepare a coping joint:

- 1) Cut the first piece of the moulding so it fits flush against the wall (in this example, the Left side)
- 2) Cut the right side of the moulding leaving a 45 degree angle on the moulding.
- 3) Using the coping saw, cut along the line created by the mitre cut. Angle the coping saw slightly so more material is taken from the back side of the moulding.
- 4) Test fit the moulding pieces. You might need to cut away additional material from the coped piece of moulding, but do not cut past the cutting line.

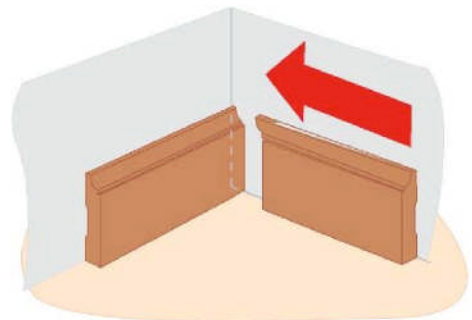
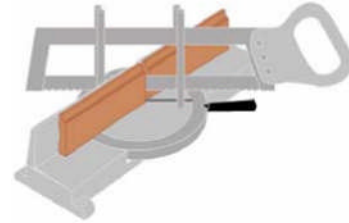

Basic Mitre Cuts

Inside and Outside Base Corners

One common place you may use basic mitre cuts are the inside and outside corners of the room. If the corners of the room form a perfect 90 degree angle, you might try 45 degree mitre cuts and slide them into the corner as shown. If you have an adjustable mitre saw, you might try adjusting the cutting angle slightly on one of the pieces to achieve a tighter fit.

Keep a sample piece of the moulding handy for test fitting. Be sure to press the moulding tightly against the wall when test fitting to simulate how the moulding may fit when nailed.

When measuring the length of your cuts, determine the actual length of the finished cut, making allowances for the angled portion left by the mitre cut.

Coping a Joint

To make a tighter, more full proof joint, refer to the section listed above on *Basic Coping Cuts*.

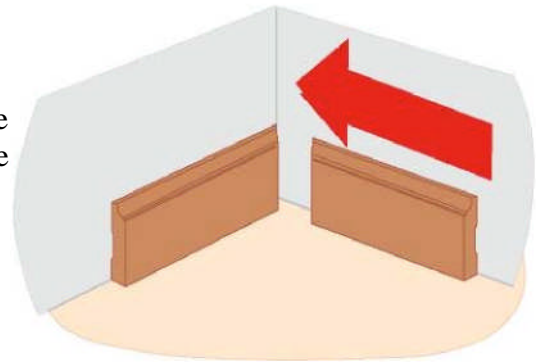
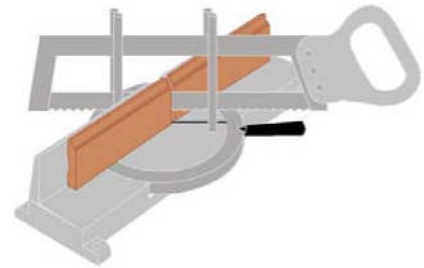

Casings

Casings are mouldings that are often used to trim windows, doors, and other wall openings. Mitred cuts on casings will often be determined by the opening they surround. In other situations the following procedures may be used to create square mitres.

Overlap Casings

One way to create an accurately mitred corner is to overlap the casings and mark the cutting line as indicated below. Be sure to extend the line to both pieces, then use them as a guide for cutting on the mitre saw.

Tip: If you don't have a mitre saw available, you can nail the casings together at the desired angle, and then cut through both pieces at the cutting line. The remaining pieces will fit together correctly. The nail holes can be filled and sanded smooth during finishing.

When installing casings, glue each face of the casing as shown, and use finishing nails to keep them from separating.

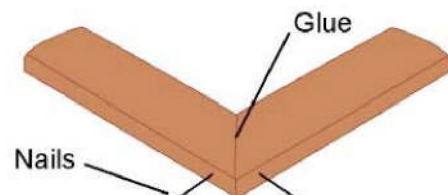
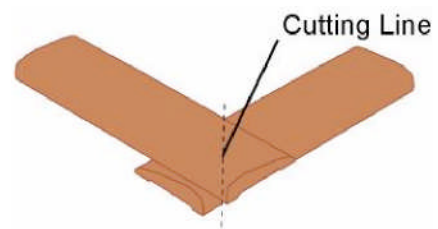

Crowns

Crowns mouldings used on ceilings benefit greatly from coped joints. Crowns are often larger than other mouldings and are usually installed at a 45 degree angle. They are more likely to have uneven joints due to variances in walls and ceilings. If you are planning a major crown installation project, learning to cope the joints would be very helpful.

A power mitre saw is also very helpful when installing crowns.

To make a coping joint with crowns, follow the method described in *The Mitre Cut Method*.

To prepare a coping joint:

- 1) Cut the first piece of crown so it fits flush against the wall (in this example, the Left side)
- 2) Cut the right side of the crown leaving a 45 degree mitre.
- 3) Using the coping saw, cut along the line created by the mitre cut. Angle the coping saw slightly so more material is taken from the back side of the crown.
- 4) Test fit the crown pieces. You might need to cut away additional material from the coped piece of moulding, but do not cut past the cutting line.

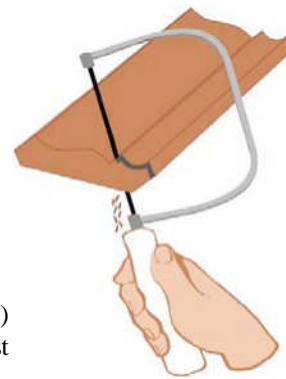
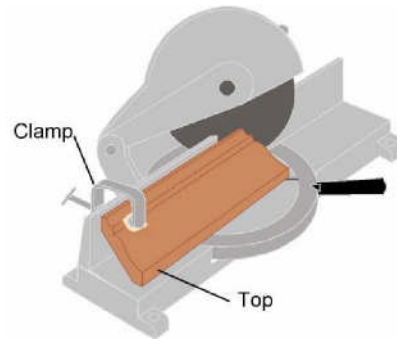
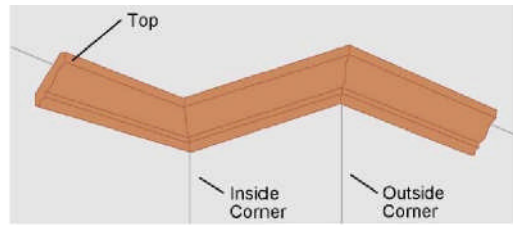

Additional Installation Tips

Tip: Planning your cuts. Make a list of all the head and side lengths (plus 10%) that you will need to complete your project. Plan your cuts to maximize the best use lengths that you are likely to buy.

Tip: To prevent splitting in this usually thin edge of the casing, keep your nails back at least one inch from the ends of the molding.

Tip: Back-cutting your mouldings slightly will often result in a tighter fit – especially on inside corners where wall surfacing materials tend to build up. Use a coping saw and remove some of the material from the back of the moulding as shown. Do not cut past the cut finished edge of the mitre cut.

